

raffaella

living

rossin
design
culture
since
1964

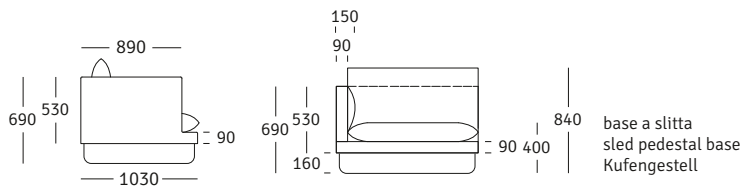

Art. 7302S

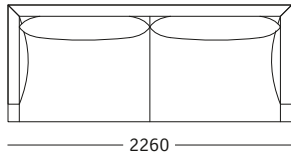

Art. 7322S

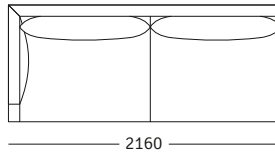

Art. 7323S

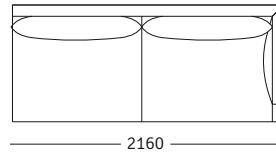

Art. 7306S

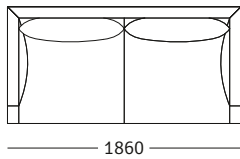

Art. 7326S

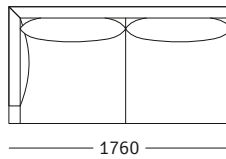

Art. 7327S

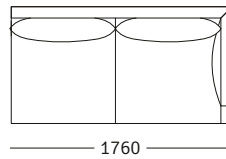

Art. 7308S

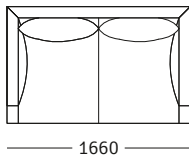

Art. 7330S

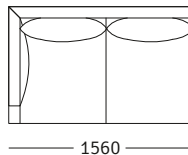

Art. 7331S

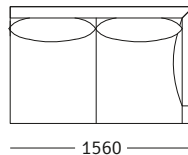

Art. 7336S

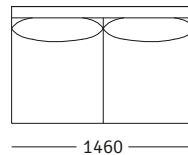

Art. 7344S

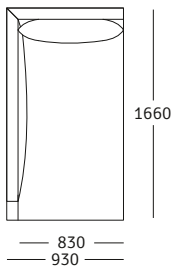

Art. 7345S

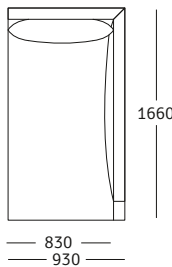

Art. 7316S

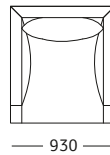

Art. 7389S

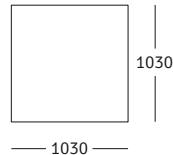

raffaella

living

rossin
design
culture
since
1964

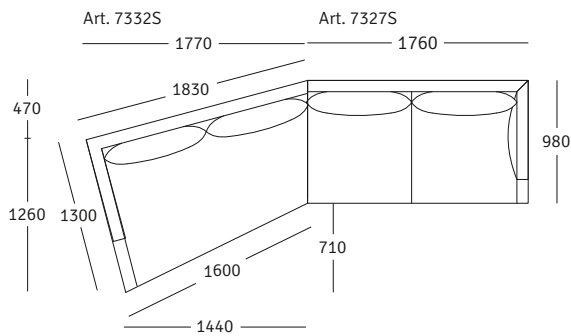
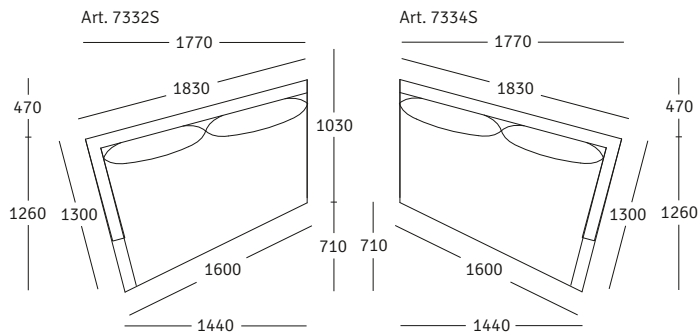
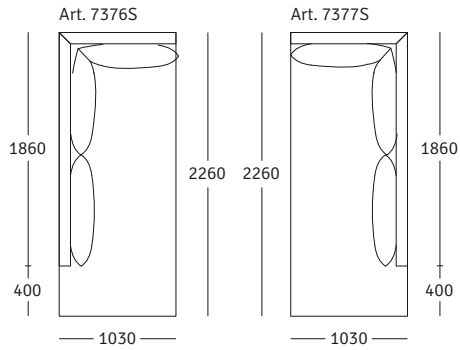

raffaella

living

rossin
design
culture
since
1964

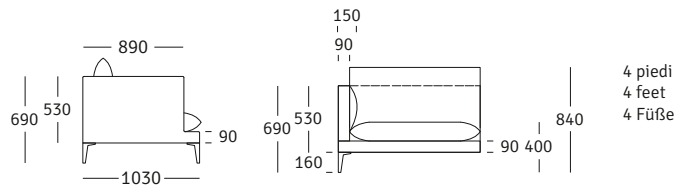

Art. 7302

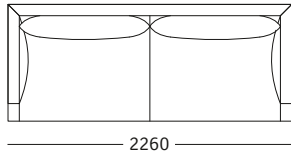

Art. 7322

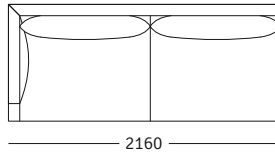

Art. 7323

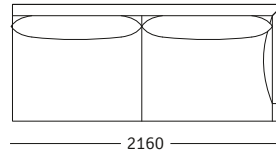

Art. 7306

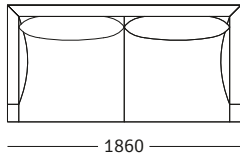

Art. 7326

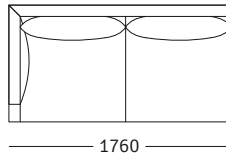

Art. 7327

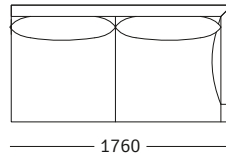

Art. 7308

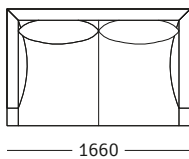

Art. 7330

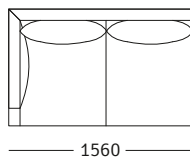

Art. 7331

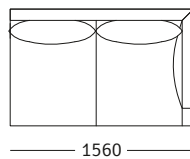

Art. 7336

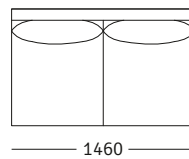

Art. 7344

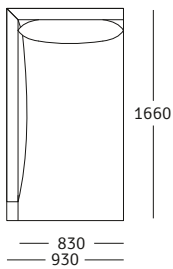

Art. 7345

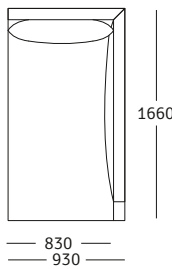

Art. 7316

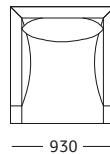

Art. 7389

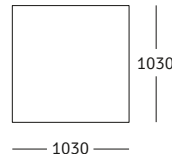

Art. 7376

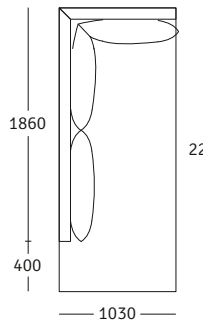

Art. 7377

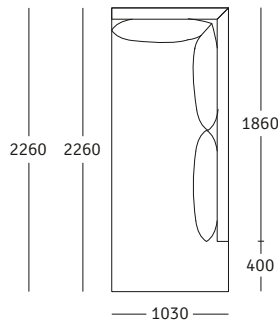

raffaella

living

rossin
design
culture
since
1964

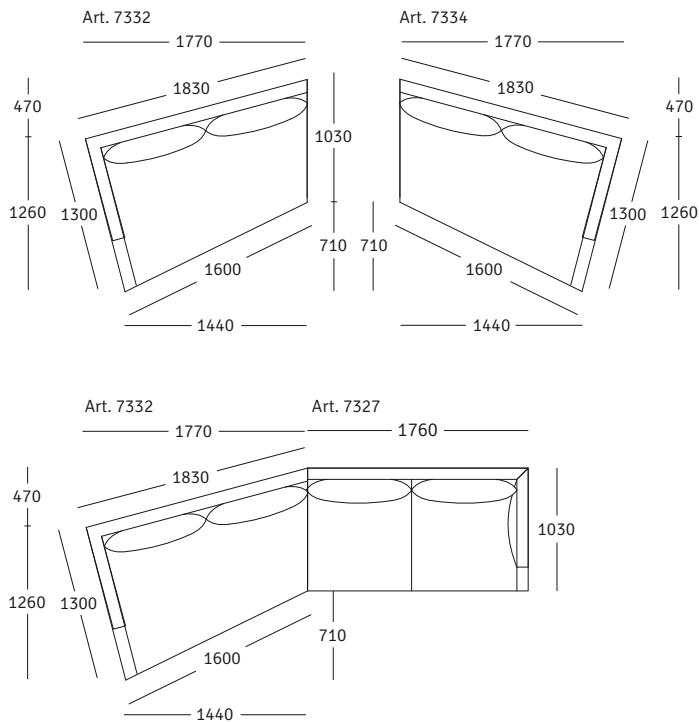

IT

Una forma originale, ricca di particolari raffinati, finiture da sartoria artigiana, morbidezza delle imbottiture danno un risultato ottimale sotto ogni aspetto. La componibilità consente scelte d'arredo particolarmente ardite.

EN

Original shape, refined details, artisan tailoring finishes and softness of the padding provide to the best result from any point of view. Its modularity allows audacious furnishing solutions.

DE

Eine originelle Form, reich an raffinierten Details, handwerkliche Näharbeiten und die Weichheit der Polsterung ergeben in jeder Hinsicht ein hervorragendes Resultat. Die Modularität erlaubt besonders kühne Einrichtungsentscheidungen.